

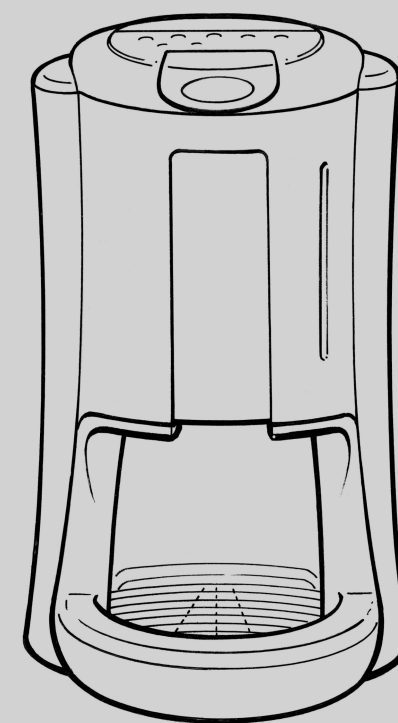

**FLAVIA® Creation 200™/MC**  
**User Guide**  
**Guide Utilisateur**  
**USA / CANADA**



[myflavia.com](http://myflavia.com)

© FLAVIA ®/™/® & designs Mars Drinks 2009

70-41-2871 Issue 1

[www.myflavia.co.uk](http://www.myflavia.co.uk)

## SAFETY PRECAUTIONS

### GENERAL USE

In order to prevent harm or injury to those using the Brewer or to any other persons and/or property, please be sure to read the following safety instructions..

- ⚠ Place out of the reach of children. Children and persons with reduced physical, sensory or mental capabilities unfamiliar, or persons unfamiliar with the equipment should only use it under supervision. Not observing these precautions may cause burns, electric shock and other injury.
- ⚠ Never place outside. This system is for indoor use only.
- ⚠ Never attempt to change the specification or modify systems in any way. Any attempt to do so may result in fire or injury. If in need of assistance, please contact customer service.
- ⚠ Ensure access to the rear of the system can be achieved easily to allow isolation of the electrical and water supply.
- ⚠ Under no circumstances should you attempt to perform any servicing or repairs on this system. Inexperienced persons may cause injury or malfunction. Always call customer service.
- ⚠ To protect against fire, electric shock and injury to persons do not immerse cord, plugs or Brewer in water or other liquid.
- ⚠ Only clean specified areas as instructed.
- ⚠ Do not install where a water jet could be used.
- ⚠ Never use without placing a cup on the cupstand, under the water outlet. Hot water may get caught in the drip tray and cause burns.
- ⚠ Drain the cold water tank and keep upright for transportation and storage. Do not move when full of water.
- ⚠ Do not touch hot surfaces. Use handles or knobs where applicable.
- ⚠ Do not operate any Brewer with a damaged cord or plug or after the Brewer malfunctions, or has been damaged in any manner. Contact FLAVIA Customer Service or point of purchase.
- ⚠ The use of accessory attachments not recommended by the Brewer manufacturer may result in fire, electric shock or injury to persons.
- ⚠ Do not let cord hang over the edge of a table or counter, or touch hot surfaces.
- ⚠ Do not place on or near a hot gas or electric burner, or in a heated oven.
- ⚠ To disconnect the Brewer, switch all controls to "off" ("O" on the Power Switch), then remove the plug from the wall outlet.
- ⚠ Do not use Brewer for other than intended use.
- ⚠ Never use the Brewer at altitudes above 6500ft (2000m).
- ⚠ Never overfill the Brewer with water as this may result in electric shock.
- ⚠ Never use packs that have been stored in the refrigerator or freezer.
- ⚠ Never use packs that appear damaged in any way.

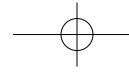

# CONTENTS

	PAGE
Safety Precautions .....	1, 2
FLAVIA® Brewer Layout .....	3
Setting up your Brewer .....	4
Priming your Brewer .....	5
Selecting your Cup .....	6
Preparing a Beverage/ Drink .....	7, 8
Getting the most from your Brewer.....	9
Daily care of your Brewer.....	10
Weekly care of your Brewer.....	11
Periodic Maintenance .....	12
Water Filter Replacement.....	13
Changing from 'Manual Fill' to 'Plumbed'.....	14
Troubleshooting .....	15
Safety & Installation Guidelines.....	16
Installation of your Brewer .....	17

ENG

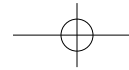
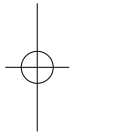
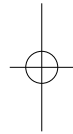

## BREWER LAYOUT

### EXTERIOR

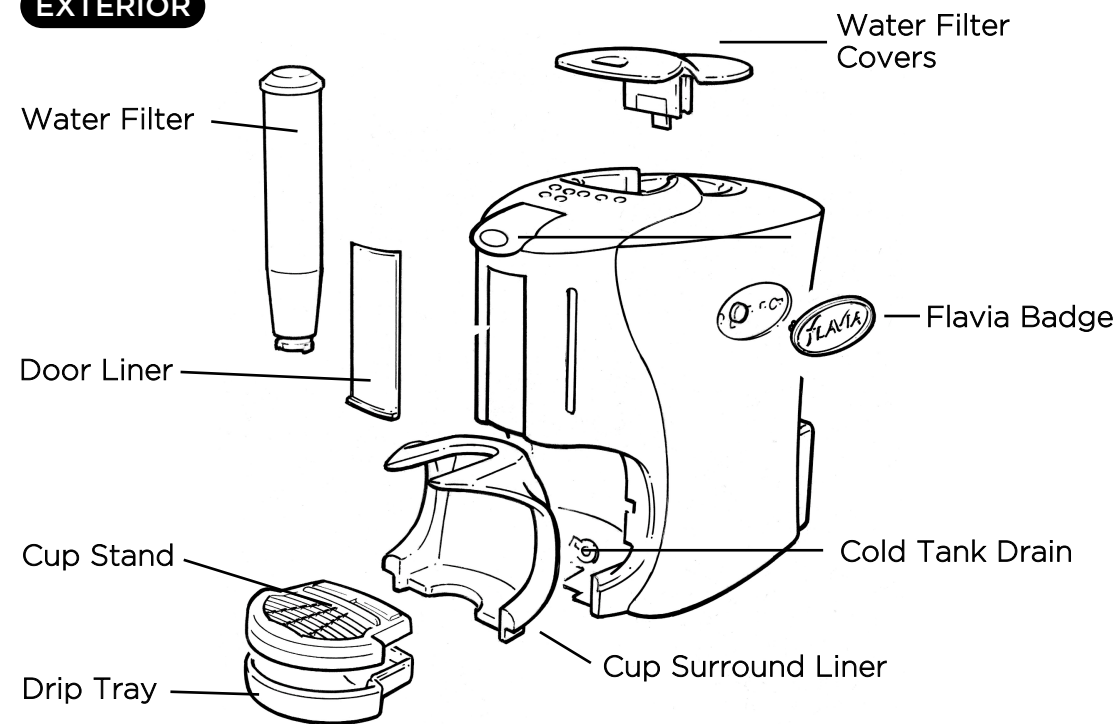

## USER INTERFACE ILLUMINATED ICONS

The user Interface has hidden icons, which will illuminate as required

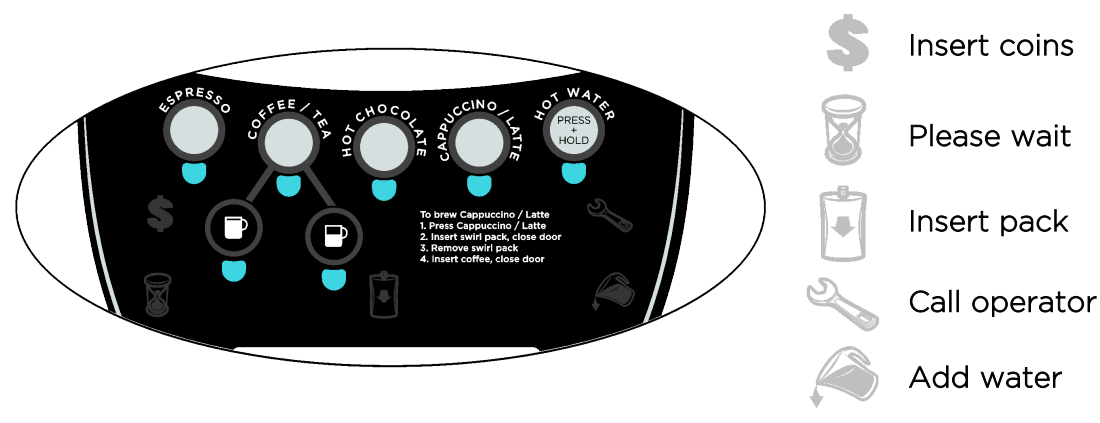

## SAFETY AND INSTALLATION GUIDELINES

We at Mars Drinks are committed to safety in all aspects of our product design, manufacture, installation and service.

### SYSTEM APPROVALS

This system has been designed and manufactured in accordance with legislation relating to Safety and FCC requirements.

### WARNINGS AND GUIDANCE

These warnings are provided in the interests of safety. Please read them carefully and ensure anyone who is involved with routine cleaning and loading also reads them.

- Ensure that the machine is kept on a level surface.
- This system is for indoor use only. Never place outside, or allow to freeze. If freezing occurs contact customer service or your local FLAVIA® supplier.
- It is dangerous to change the specification or modify the systems in any way
- Ensure access to the rear of the system can be achieved easily to allow isolation of the electrical and water supply
- Under no circumstances should you attempt to perform any servicing or repairs on this system. Inexperienced persons may cause injury or malfunction. Always call customer service or your local FLAVIA® supplier.
- Do not immerse system in water
- Only clean in specified areas as instructed
- Do not install where a water jet could be used.
- Supervision is required if the system is to be used by young children, aged or infirm persons.
- This system contains electronic circuits. **Do not flash test.**
- Observe recommendations relating to regular inspection and testing of this system.
- An ambient temperature range of +41°F to +86°F is recommended for system location.

### IMPORTANT NOTES

- The system is flash tested before it leaves the manufacturing premises. Repeated flash testing can damage insulation.

**Notice** • DO NOT FLASH TEST THIS EQUIPMENT

### ELECTRICAL CONNECTION

- If the plug is damaged it should be removed from the voltage supply, cut off and disposed of carefully. **NEVER ATTEMPT TO RE-USE.**
- If the mains cord or plug is damaged never attempt to replace; contact customer service or your local FLAVIA® supplier.
- Never attempt to plug in a cut-off plug into a mains socket. Such action may present a shock hazard.

## INSTALLATION OF YOUR FLAVIA® BREWER

### Brewer Dimensions

Height - 15.5" (394mm)      Width - 9.5" (241mm)      Depth - 15.5" (394mm)

A gap of 2.5" (60mm) is required behind the Brewer if it is to be plumbed in.

### Electrical Supply

It is important that you have a power supply ready so that we can install your new system quickly and efficiently.

You will need to supply a suitable switched electrical supply to meet the requirements for isolation of electrical equipment.

i.e. A 15 Ampere requires a 15 Ampere switched socket or a lockable isolator

Only use a 120V AC 60Hz single phase power supply.

Use only one system per socket and ensure it is earthed.

Your system comes supplied with a mains lead, 6' (1.82m) in length. Only this lead should be used, no old leads should be re-used.

#### Notice

- If you are unsure about any installation requirements, consult an electrician and/or a plumber.

### Plumbed Systems

A plumbed system will need a mains drinking water supply.

Brewer to be connected to cold water supply only.

Water pressure must be between a maximum of 0.7 MPa (7 bar, 100 psi) and a minimum of 0.1 Mpa (1 bar, 14.5 psi).

Flow Rate to be at least 8.45oz/minute

Using the brass elbow supplied with your Brewer, connect your Brewer to the cold water supply with a suitable 1/4" diameter water pipe.

#### Notice

- Do not use water that has come from a water softener or contains sodium.
- Install in accordance with local plumbing regulations.
- Jointing compound should not be used in the water supply to the system, as this will affect the drink flavour, only use PTFE tape.
- Do not locate the water supply above the mains power socket.
- System should be installed with supplied internal water filter

### Installing

Please contact customer service or your local FLAVIA® supplier for your Brewer to be installed.

## SAFETY PRECAUTIONS

- ⚠ Never tilt, shake or turn the Brewer upside down, as this may result in spillage and/or serious damage to the machine.
- ⚠ Do not put milk, alcohol or anything other than cold, fresh water in the Water Reservoir. This may result in serious damage to the Brewer.
- ⚠ Do not use sodium softened water.
- ⚠ Ensure that the cup or mug is of adequate size for the drink you are brewing. Failure to do so may lead to overflow which could cause burns.
- ⚠ Never remove the cup during the brewing cycle as this may cause burns.
- ⚠ Never open the Pack Door during the brewing cycle as this may cause burns.

### ELECTRICAL SUPPLY AND CORD

- ⚠ Never do anything that might cause damage to the cord or plug, (such as modify them, place hot or heavy objects on them, bend them, stretch them, or twist them). If the Brewer is used when damaged, electrical short circuit or fire may result. If in need of repair please contact your local FLAVIA® Customer Service Officer
- ⚠ Clean the plug from dust regularly. A build-up of dust on the plug will attract condensation, which could cause cable damage resulting in fire. Remove the plug and clean with a dry non-conductive cloth.
- ⚠ The Brewer must be earthed. Failure to do so may result in electric shock.
- ⚠ Make sure the plug is correctly inserted in the power socket. An unsafe plug may cause electric shock or generate heat resulting in fire. Do not use a damaged plug or loose power socket.
- ⚠ 120V socket must not be used with other appliance. When used alongside other appliances, heat generated may result in fire.
- ⚠ Never plug or unplug the Brewer with wet hands. This may result in electric shock.

Remove the plug from the AC outlet only when the Brewer is switched off (not in use). Deteriorating insulation may result in electric shock and/or fire.

When unplugging the Brewer, always pull by the Plug - NOT THE CORD!

ENG

## PRIMING YOUR BREWER

BEVERAGES CAN NOT BE BREWED UNTIL THE BREWER HAS BEEN PRIMED

**Note**

If the Brewer is to be set for 'plumbed' operation refer first to the Section headed CHANGING FROM 'MANUAL FILL' TO 'PLUMBED'

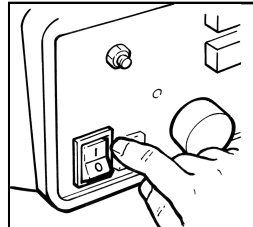

The priming cycle fills the boiler with water. After this your Brewer will be ready for use.

**Step 1**

Plug the Brewer into the AC outlet. Turn the switch on the back of the Brewer to the 'ON' position. The 'ADD WATER' symbol on the top of the Brewer will flash.

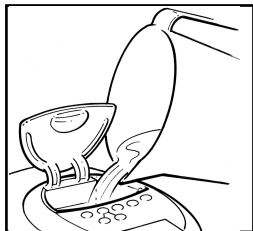

**If your Brewer is to be used in 'manual fill' operation**

Lift the 'Filler Lid' on the top of the Brewer, and carefully fill with cold drinking water to no higher than the 'MAX' level. It is important to fill to the 'MAX' level, as this sets the Brewer to 'MANUAL FILL' operation. This is only necessary on the first fill out of the box.

Volume of water required for Initial Fill to 'MAX' level from empty.	
With Filter Fitted	= 110 fl oz (3.3L)
Without Filter Fitted	= 120 fl oz (3.6L)

The 'Hot Water' button and 'CALL OPERATOR' symbol on the top of the Brewer will now flash

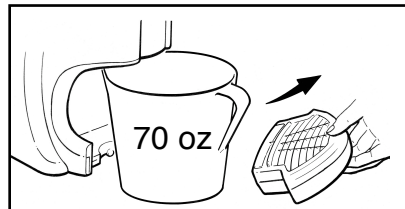

**Step 2**

Remove the drip tray from the Brewer and place a large container of at least 70 oz (2.0L) under the drinks dispense area.

**Note**

Before commencing to the next step please lift the handle and ensure that no filter-packs are located. Then close the handle ensuring the sliding door is closed.

**Step 3**

Now Press the 'HOT WATER' button to begin the PRIME cycle.

The Brewer will start to 'pump', and after several seconds water will be dispensed into the container. The Brewer will automatically stop pumping after about 2 minutes when the flush cycle is finished. It will pump approximately 60 fl oz (1.7L) of water.

The water jet may be seen to 'splutter' for a short while, this is normal.

The water flow can be stopped and re-started by pushing the 'HOT WATER' button, if required.

The system is now primed and will begin to heat the water. When complete the 'Drinks Selection' lights will illuminate.

Your Brewer is now ready to start making drinks.

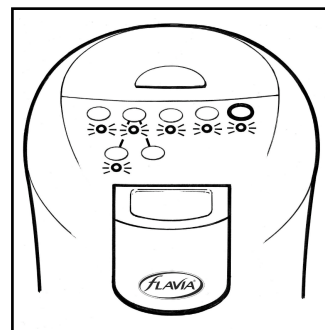

**If your Brewer is set for 'plumbed' operation**

your Brewer will automatically draw sufficient water from the supply. Please wait as this process may take a few moments. Please do not fill your Brewer manually as this may automatically return your machine to being set for 'manual fill'.

## CHANGING FROM 'MANUAL FILL' TO 'PLUMBED'

**MAKE SURE YOUR APPLIANCE IS SWITCHED OFF.**

**Step 1**

Make sure that the water reservoir has been drained. See section headed DRAINING THE COLD WATER RESERVOIR.

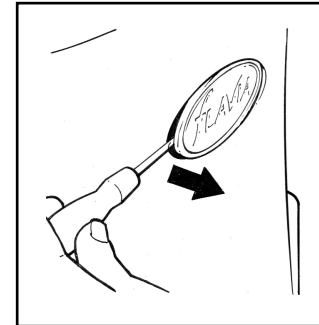

**Step 2**

Remove the FLAVIA badge from the right hand side of the Brewer.

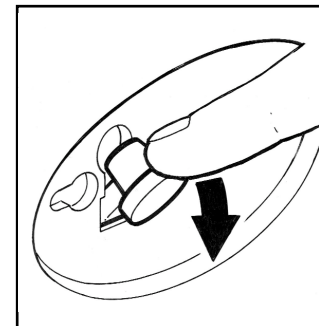

**Step 3**

Pull the red rubber switch towards you and replace. This will reset the overflow switch enabling a plumbed water supply to be connected.

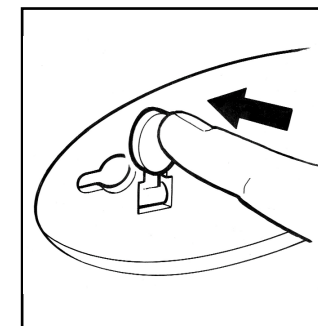

**Step 4**

Replace the FLAVIA badge.

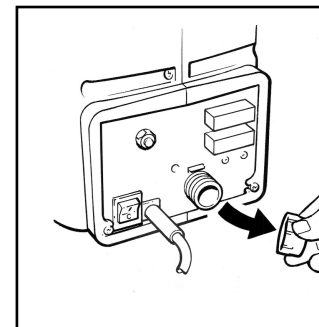

**Step 5**

At the rear of the Brewer remove the protective cap from 'mains water inlet' and connect to the water supply using the recommended inlet hose.

Refer to the 'Plumbed Systems' instructions under INSTALLATION OF YOUR FLAVIA® BREWER.

**Step 6**

Turn on the water supply, and ensure that all connections are watertight.

**Step 7**

Turn on the mains electricity supply











## TROUBLESHOOTING

The sophisticated design of your FLAVIA® Brewer makes it very unlikely that anything will go wrong. However, if faults do develop, you can resolve many of them yourself.

Please refer to the icons on the consumer interface detailed on page 8

"Flashing" = ON:OFF pulsing

"Blinking" = Slower ON:OFF pulsing

- 'CALL OPERATOR'  & 'HOT WATER' button flashing - hot tanks need priming: Ref page 5 for priming instructions.
- 'CALL OPERATOR'  & 'HOURLASS'  - main boiler fault: turn your drinks station off and please call your local customer service office.
- 'CALL OPERATOR'  flashing on its own - other fatal error: turn your drinks station off and please call your please call your local customer service office.
- 'HOURLASS'  flashing for more than 80 secs: turn your drinks station off and please call your local customer service office. Note: If your drinks station has been stored in an extreme cold environment, and his error appears, please leave switched off in a normal ambient for 12hours and then switch on.
- 'ADD WATER'  flashing for more than 60 secs when plumbed in: If the Brewer is plumbed in then please check that the mains supply is not turned off. If problem persists then please call your local customer service office.
- 'INSERT PACK'  flashing on its own: If in priming mode (ref page 5) please ensure that no filter-packs have been inserted. The priming cycle is being inhibited because a pack is present or the pack door is open.
- 'INSERT PACK'  blinking on its own - Brewer in energy-saving standby mode.
- 'DOLLAR SIGN'  flashing for 4 secs after pressing a category button - insufficient credit for that category
- 'DOLLAR SIGN'  flashing at any other time - some coin credit, but not enough for a 1-pack vend

## SETTING UP YOUR BREWER

### INSTALLING THE WATER FILTER

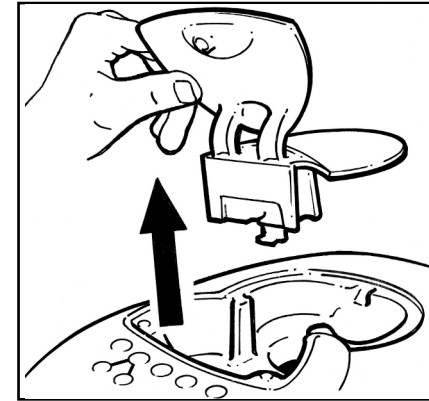

**Step 1**  
Remove the water filter cover

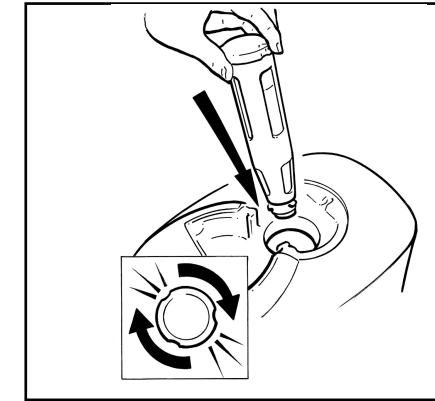

**Step 2**  
Insert the replacement filter and rotate it clockwise to engage with the bayonet fitting. Replace the water filter covers.

#### Note

At the top of the water filter cartridge there is a rotating 'date cap' which may be set to serve as a reminder of the anticipated replacement date

FOR SUBSEQUENT CHANGES OF THE WATER FILTER PLEASE REFER TO THE SECTION HEADED 'WATER FILTER REPLACEMENT'

ENG



## PREPARING A BEVERAGE/DRINK

### BREWING BEVERAGES

#### Step 1

Place a cup centrally on the cup stand and push back until it touches the backstop. Please be aware that the minimum cup size to avoid overflow is 11 oz US.

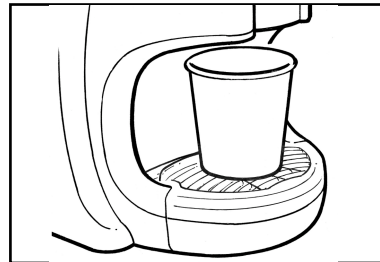

#### Step 2

Select the desired drink category from the illuminated options.

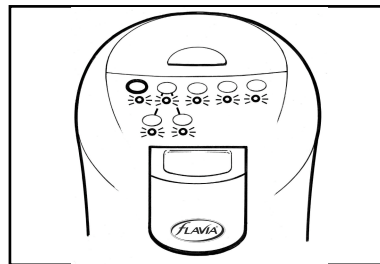

#### Step 3

If making a tea or coffee beverage, select the drink size from the illuminated options - large or small. (10 oz or 7 oz).

The 'INSERT PACK' icon will illuminate.

#### Step 4

Open the handle and insert the filter pack..

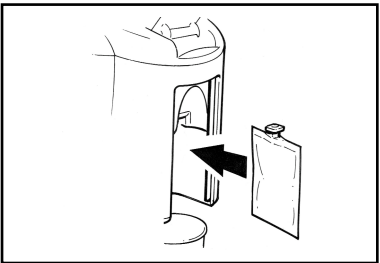
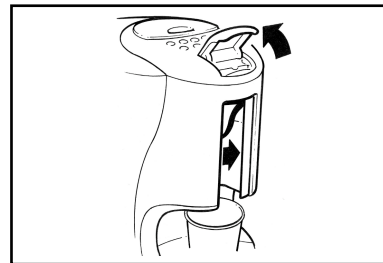

#### Step 5

Close the handle firmly. Please note that some resistance may be felt as the handle is closed. This is normal operation, this step is "piercing" the pack.

#### Step 6

Your drink will now be freshly filtered and brewed into your cup.

#### Note

All seven lights will flash on the Brewer to indicate when your beverage is ready

#### Step 7

Lift the handle and remove the filterpack for disposal.

## PERIODIC MAINTENANCE

### DRAINING THE COLD WATER RESERVOIR

On occasion it may be necessary to drain the Cold Water Reservoir. For example: when setting the Brewer for 'plumbed' operation, when transporting (or storing) the Brewer; or when refreshing the water supply.

MAKE SURE YOUR BREWER IS SWITCHED OFF.

#### Step 1

Remove the drip tray.

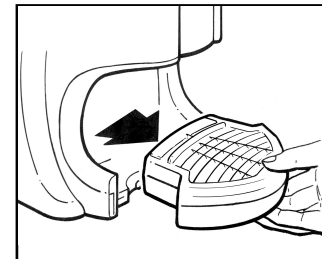

#### Step 2

Remove the cup surround liner by holding the two outer edges and pulling forward.

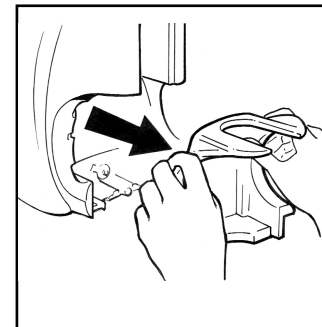

#### Step 3

Pull the machine forward to the edge of the worktop and place a large jug underneath.



#### Step 4

Remove the rubber seal and drain the water. Note that the water may flow fast, depending on how much water is held in the reservoir.

## WATER FILTER REPLACEMENT

Your Brewer is fitted with a Water Filter to ensure the water used in brewing your beverages is of optimal quality. To maintain the quality of beverages brewed, while protecting and extending the life of your Brewer, you will need to replace this filter periodically. The frequency of replacement depends on the number of drinks brewed.

*The recommended replacement frequency is approximately every 800 beverages or three months whichever comes first.*

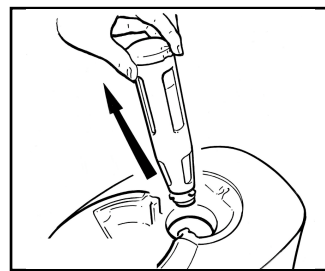
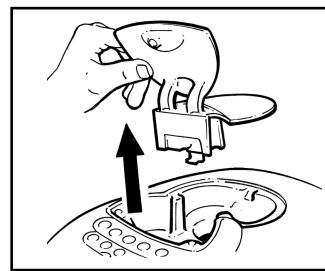

### Step 1

Remove the water filter covers to access the water filter. Remove the filter by turning it counter-clockwise. Discard the used filter.

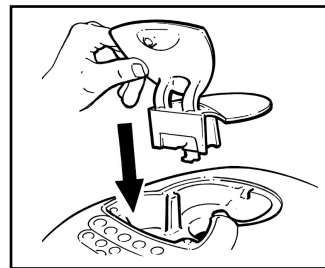
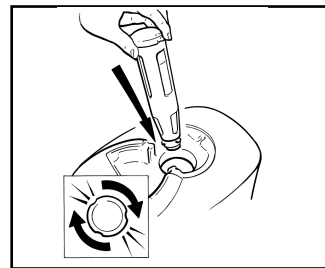

### Step 2

Insert the replacement filter and rotate it clockwise to engage with the bayonet fitting inside the cold water reservoir. Replace the water filter covers.

### Note

At the top of the water filter cartridge there is a rotating 'date cap' which may be set to serve as a reminder of the anticipated replacement date.

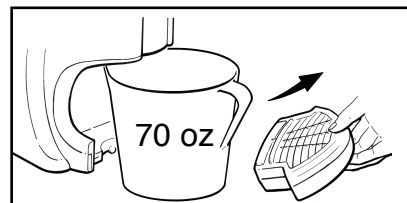

### Step 3

The new filter will need to be 'primed'. Remove the drip tray from the Brewer and place a large container in the dispense area.

### Step 4

**Turn the Brewer off. Press and hold the 'HOT WATER' and 'LARGE CUP' buttons.**

Turn the Brewer back on whilst continuing to hold the two buttons whilst the Brewer powers up. Then release the two buttons, the 'CALL OPERATOR' symbol  and 'HOT WATER' button will now illuminate.

Now Press the 'HOT WATER' button to begin the FLUSH cycle.

The Brewer will start to 'pump', and water will be dispensed into the container. The Brewer will automatically stop pumping after about 2 minutes when the flush cycle is finished. It will pump approximately 60 fl oz (1.7L) of water.

The water jet may be seen to 'splutter' for a short while, this is normal.

The water flow can be stopped and re-started by pushing the 'HOT WATER' button, if required. The system is now flushed and will begin to heat the water. When complete the 'Drinks Selection' lights will illuminate.

Your Brewer is now ready to continue making drinks.

## SELECTING YOUR CUP

1. The use of FLAVIA® paper cups is recommended. Alternative cups may be used providing they are of similar proportions to ref. H and weigh a minimum of 5g
2. A mug may be used providing it is of similar shape and proportions to ref. H
3. Use of cups that do not meet the recommended criteria may result in overflow or mess creation
4. For further advice on cups and mugs suitable for use with your Brewer please contact customer service or your local FLAVIA® supplier

### Caution

Please be aware that the minimum cup size for use with a large drink to avoid overflow is 11oz (325ml)

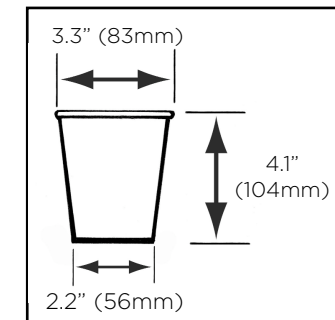

(Ref. H)

Minimum weight 5g

## GETTING THE MOST FROM YOUR BREWER

### PURE WATER FOR THE FINEST TASTING BEVERAGES EVERY TIME

For a great-tasting hot beverage in every cup, replace the FLAVIA® filter every three months. FLAVIA® filter cartridges will help protect your FLAVIA® CREATION drinks station and extend its life. The organic ion exchangers and activated charcoal within the filter reduce heavy metals and other contaminants, as well as substances such as chlorine which could impair the flavour and aroma of your hot beverage. The filter goes straight in the reservoir and does not require any additional accessories to install. It also does not take up any extra worktop space. Please contact Customer Service for details on how to order replacement FLAVIA® Filters.

### PACKS

Packs should be stored in a cool dry place. If unopened, your packs will remain fresh and continue to make excellent drinks right up to the best before date shown on the back of the pack. **Packs should not be stored in a refrigerator or freezer.**

### CUPS/MUGS

To avoid spillage or burns, please ensure that you always use the correct size cup or mug. This should give a minimal distance from the rim of the cup to the underside of the filter-pack when inserted. To minimise vending mess please avoid rounded bottom cups.

### BEVERAGE SELECTION BUTTONS

Your Brewer is fitted with selection buttons, which enable a wide choice of beverages to be made.

## DAILY CARE

### EMPTYING THE DRIP TRAY

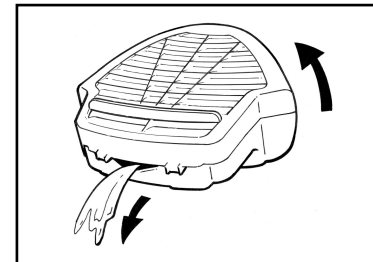

**Step 1**  
Lift out the drip tray and drain liquid contents

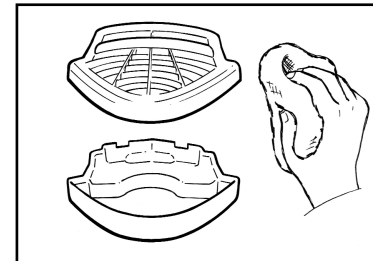

**Step 2**  
Separate the drip tray, liner and cup stand and clean them in warm soapy water. Wipe the surrounding area of the Brewer clean with a damp cloth.

**Step 3**  
Reassemble and replace drip tray.

#### Note

Your Brewer does not tell you when the drip tray is full, so make sure that you check it regularly.

### REFILLING WITH WATER (APPLIANCES SET FOR 'MANUAL FILL' ONLY)

The Brewer will illuminate the 'ADD WATER' symbol  when it requires refilling.

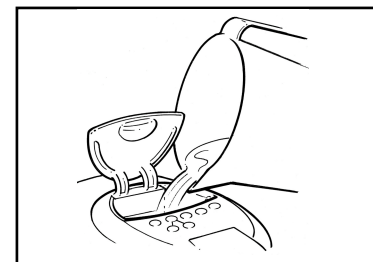

**Step 1**  
Lift the 'Filler lid'.

**Step 2**  
Carefully fill the reservoir with drinking water (no higher than the 'MAX' level)

During operation the water level may be monitored through the sight tube (visible from the front of the Brewer).

Volume of water required to fill to 'MAX' level from 'LOW' level indication

With Filter Fitted	= 90 fl oz (2.7L)
Without Filter Fitted	= 100 fl oz (3.0L)

## WEEKLY CARE

### GENERAL CLEANING

Wipe the outside of the Brewer with a damp cloth.

Remove the door liner by pulling downwards when the handle is in the 'down' position. Clean with a damp cloth and replace. Remove the drip tray pull the handle up and clean the area indicated on the diagram.

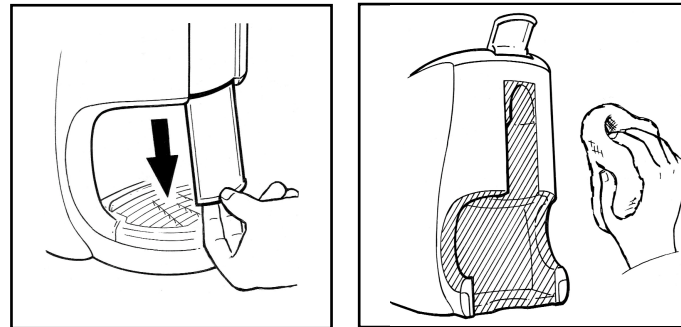

Do not clean with brushes or scouring agents as this may damage the surface of your Brewer.  
 Do not wash with excessive amounts of water, it could get into the Brewer causing a malfunction.  
 Do not use cleaning agents as they may leave a residue on the Brewer.  
 Do not apply any products that contain benzene, they may damage the surface of your Brewer.  
 Do not use strong detergents.  
 Take care not to get soapy water into the water tank as this will affect drink taste.

## PREPARING A BEVERAGE/DRINK

### BREWING CAPPUCCINO / LATTE DRINKS

Follow **Steps 1-5** above.

At **Step 2** the 'CAPUPUCCINO/LATTE' category should be selected.

At **Step 4** a 'CAPUPUCCINO/LATTE SWIRL' filterpack should be inserted

#### Step 6

At the end of the first brew, the 'INSERT PACK' indicator will flash. This is a prompt for you to insert the second filter pack, which should be a FLAVIA coffee filterpack.

Open the handle, remove the first filter pack and insert the second filterpack. Close the handle firmly. The Brewer will now start to brew the second pack of your beverage.

It is important that the packs are placed in the correct order. Please see the packs for further information.

#### Step 7

Lift the handle and remove the filterpack for disposal.

#### Note

All seven lights will flash on the Brewer to indicate when your beverage is ready

### LARGE/TRAVEL MUG FACILITY

To vend your drink into a large mug remove the drip tray, place your mug and follow the normal drink making steps.

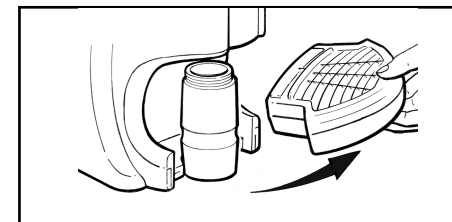

### HOT WATER FACILITY

Your Brewer can also vend hot water if required,

With no filterpack in place press and hold 'HOT WATER' button. Hot water will begin to flow whilst the button is pressed. Release the button to stop the water flowing.